

itC IP NETWORK PA SYSTEM

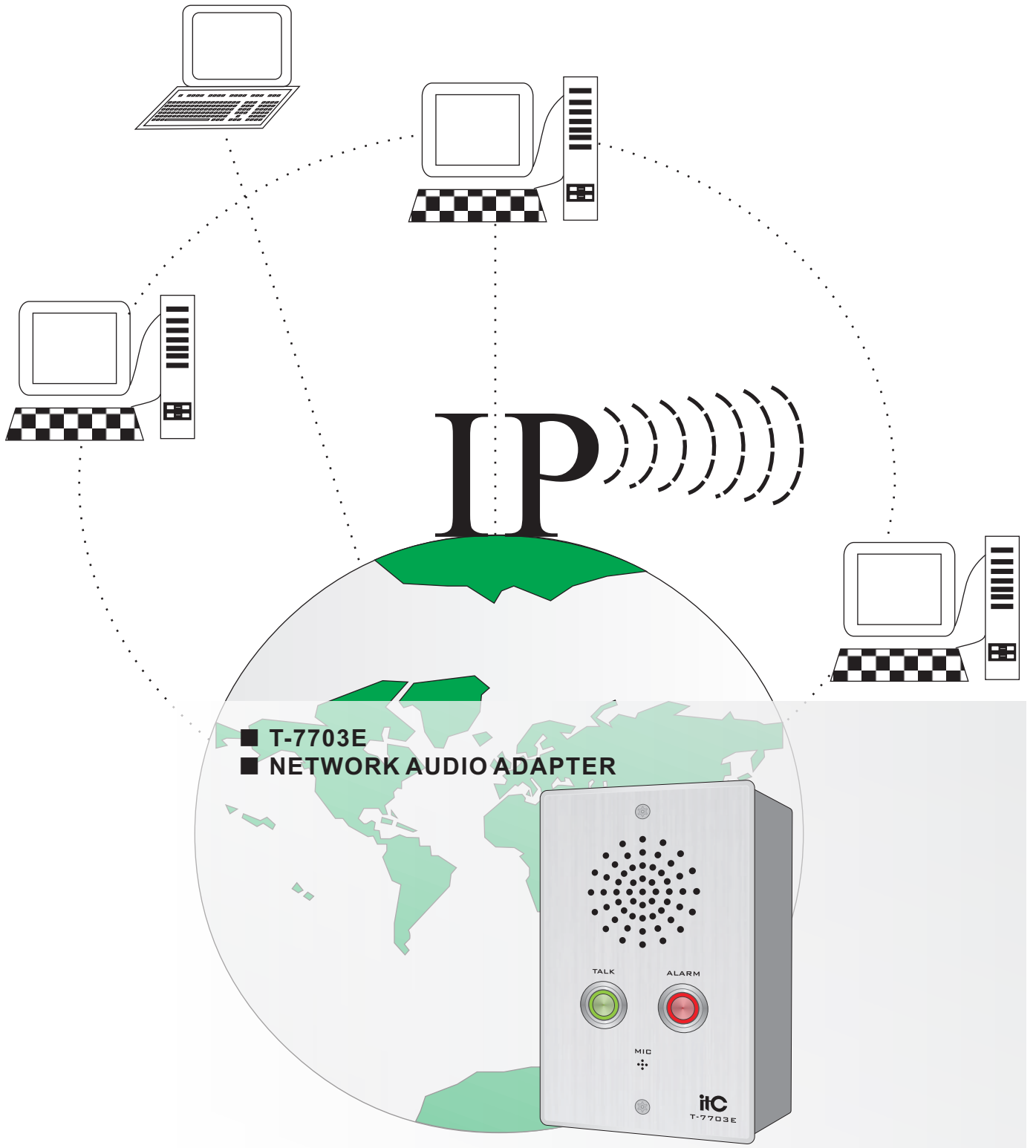

OWNER'S MANUAL



Please follow the instructions in this manual to obtain the optimum results from this unit. We also recommend that you keep this manual handy for future reference.

TABLE OF CONTENTS

1. SAFETY PRECAUTIONS.....	3
2. APPLICATION.....	5
3. FEATURES.....	5
4. NOMENCLATURE AND FUNCTIONS.....	6
4.1 Front panel.....	6
4.2 Wiring diagram.....	6
5. TERMINAL CONFIGURATION OPERATING INSTRUCTIONS	7
6. OPERATION	10
7. BLOCK DIAGRAM.....	11
8. SPECIFICATIONS.....	12
9. BOTTOM CASE INSTALLATION DIMENSION FIGURE.....	13

1. SAFETY PRECAUTIONS

- Be sure to read the instructions in this section carefully before use.
- Make sure to observe the instructions in this manual as the conventions of safety symbols and messages regarded as very important precautions are included.
- We also recommend you keep this instruction manual handy for future reference.

Safety Symbol and Message Conventions

Safety symbols and messages described below are used in this manual to prevent bodily injury and property damage which could result from mishandling. Before operating your product, read this manual first and understand the safety symbols and messages so you are thoroughly aware of the potential safety



Indicates a potentially hazardous situation which, if mishandled, could result in death or serious personal injury.



Indicates a potentially hazardous situation which, if mishandled, could result in moderate or minor personal injury, and/or property damage.



When Installing the Unit

- Do not expose the unit to rain or an environment where it may be splashed by water or other liquids, as doing so may result in fire or electric shock.
- Use the unit only with the voltage specified on the unit. Using a voltage higher than that which is specified may result in fire or electric shock.
- Do not cut, kink, otherwise damage nor modify the power supply cord. In addition, avoid using the power cord in close proximity to heaters, and never place heavy objects -- including the unit itself -- on the power cord, as doing so may result in fire or electric shock.
- Be sure to replace the unit's terminal cover after connection completion. Because high voltage is applied to the speaker terminals, never touch these terminals to avoid electric shock.
- Be sure to ground to the safety ground (earth) terminal to avoid electric shock. Never ground to a gas pipe as a catastrophic disaster may result.
- Avoid installing or mounting the unit in unstable locations, such as on a rickety table or a slanted surface. Doing so may result in the unit falling down, causing personal injury and/or property damage.

When the Unit is in Use

- Should the following irregularity be found during use, immediately switch off the power, disconnect the power supply plug from the AC outlet and contact your nearest ITC dealer. Make no further attempt to operate the unit in this condition as this may cause fire or electric shock.
 - If you detect smoke or a strange smell coming from the unit.
 - If water or any metallic object gets into the unit
 - If the unit falls, or the unit case breaks
 - If the power supply cord is damaged (exposure of the core, disconnection, etc.)
 - If it is malfunctioning (no tone sounds.)
- To prevent a fire or electric shock, never open nor remove the unit case as there are high voltage components inside the unit. Refer all servicing to your nearest ITC dealer.
- Do not place cups, bowls, or other containers of liquid or metallic objects on top of the unit. If they accidentally spill into the unit, this may cause a fire or electric shock.
- Do not insert nor drop metallic objects or flammable materials in the ventilation slots of the unit's cover, as this may result in fire or electric shock.

CAUTION

When Installing the Unit

- Never plug in nor remove the power supply plug with wet hands, as doing so may cause electric shock.
- When unplugging the power supply cord, be sure to grasp the power supply plug; never pull on the cord itself. Operating the unit with a damaged power supply cord may cause a fire or electric shock.
- When moving the unit, be sure to remove its power supply cord from the wall outlet. Moving the unit with the power cord connected to the outlet may cause damage to the power cord, resulting in fire or electric shock. When removing the power cord, be sure to hold its plug to pull.
- Do not block the ventilation slots in the unit's cover. Doing so may cause heat to build up inside the unit and result in fire.
- Avoid installing the unit in humid or dusty locations, in locations exposed to the direct sunlight, near the heaters, or in locations generating sooty smoke or steam as doing otherwise may result in fire or electric shock.

When the Unit is in Use

- Do not place heavy objects on the unit as this may cause it to fall or break which may result in personal injury and/or property damage. In addition, the object itself may fall off and cause injury and/or damage.
- Make sure that the volume control is set to minimum position before power is switched on. Loud noise produced at high volume when power is switched on can impair hearing.
- Do not operate the unit for an extended period of time with the sound distorting. This is an indication of a malfunction, which in turn can cause heat to generate and result in a fire.
- Contact your ITC dealer as to the cleaning. If dust is allowed to accumulate in the unit over a long period of time, a fire or damage to the unit may result.
- If dust accumulates on the power supply plug or in the wall AC outlet, a fire may result. Clean it periodically. In addition, insert the plug in the wall outlet securely.
- Switch off the power, and unplug the power supply plug from the AC outlet for safety purposes when cleaning or leaving the unit unused for 10 days or more. Doing otherwise may cause a fire or electric shock.

An all-pole mains switch with a contact separation of at least 3 mm in each pole shall be incorporated in the electrical installation of the building.

2. APPLICATION

1. Professional one key for help network intercom terminal.
2. It fits indoor-outdoor environment installation, anti-explosive and waterproof; it can be launched one key intercom communication to duty room.

3. FEATURES

1. Simple appearance, graceful line, high-grade alumina brushed aluminum foil panel, strong and durable, can be embedded installation or surface installation (with bottom box).
2. Equipment with embedded computer technology and DSP audio processing technology design; Adopting high speed industrial chip, start time less than 1 second.
3. One key for hep, call duty room intercom microphone, realize the quick link, simple operation.
4. Built-in 2W High-fidelity full frequency speaker, clear and loud phone voice.
5. Built-in high sensitive mic, wide area voice collecting and high sound reproduction.
6. Support hands-free calls and receive broadcast.
7. One way audio output, external expansion power amplifier.
8. One way short circuit input, can be used as a trigger preset voice prompt (or alarm).
9. One way alarm trigger circuit output, cascade connection external expansion warning device.
10. DC power supply port, DC 24V external adapter.
11. Whole cast aluminum bottom case, embeddable or surface installation.
12. IP55 grade, using alloy material and anti-disassembly screw entirely, anti-explosive and waterproof.
13. It can access if there is Ethernet front-end ports, support different network segment and routing.

4. NOMENCLATURE AND FUCTIONS

4.1 Front panel

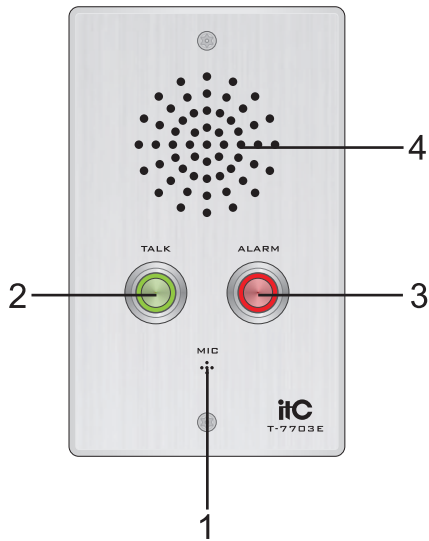

1. Mic port audio input, it can call or intercom when centers on the port.
2. Intercom/reset buttons and status indicators, can be directly call intercom and reset the factory IP address.
3. Alarm button and alarm status indicator light.
4. Intercom monitor speaker.

4.2 Wiring diagram

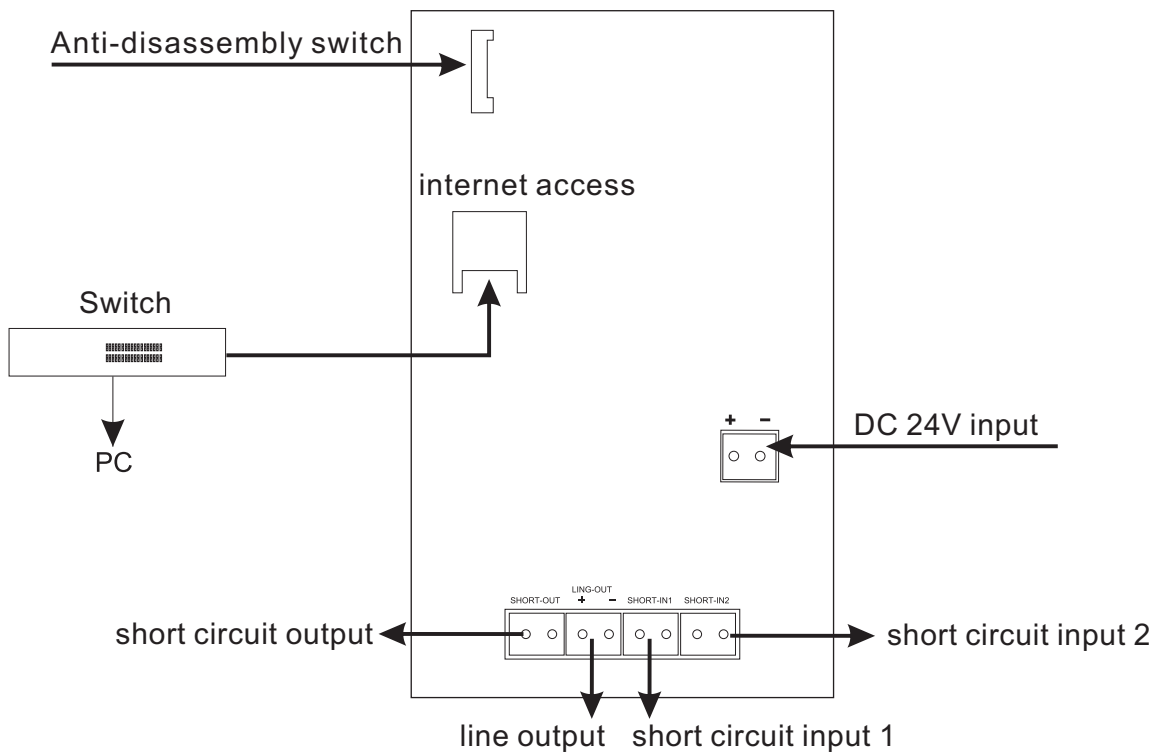

5. TERMINAL CONFIGURATION OPERATING INSTRUCTIONS

The terminal needs to be configured before installation, before installation, need make a installation plan including terminal name, terminal IP address, gateway IP address, server IP address, location of terminal installation, and label the information on the terminal to ensure the convenient use of the device. Please save the plan as an electronic document for future maintenance. After the system planning is completed, please configure parameters of each terminal includes “terminal IP address, subnet mask, gateway and server address”.

1. Installing software. Find the IP network broadcast system software installation package, double-click to open it, click on the program “terminal configuration tool”, after the installation of the program is completed, as shown below:

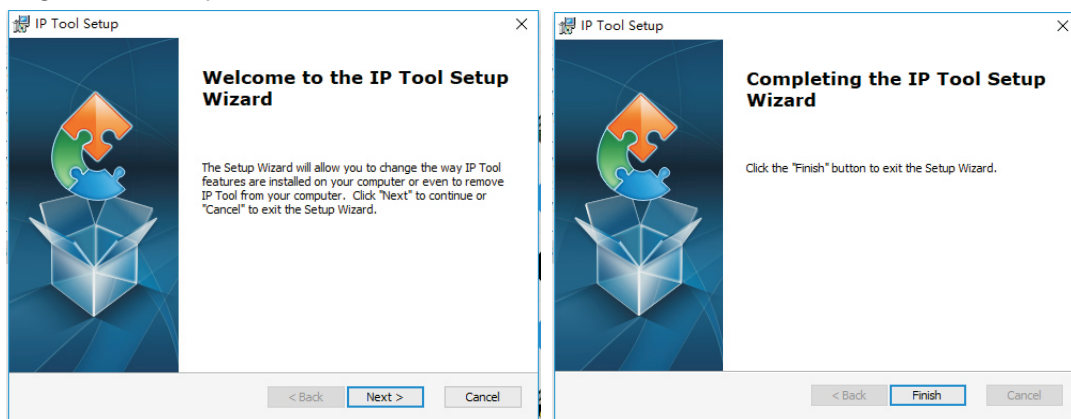

2. After the program is installed, a icon is generated on the desktop, as shown below:



3. Double-click the icon to run, and the “terminal configuration tool” window will pop up, as shown below:

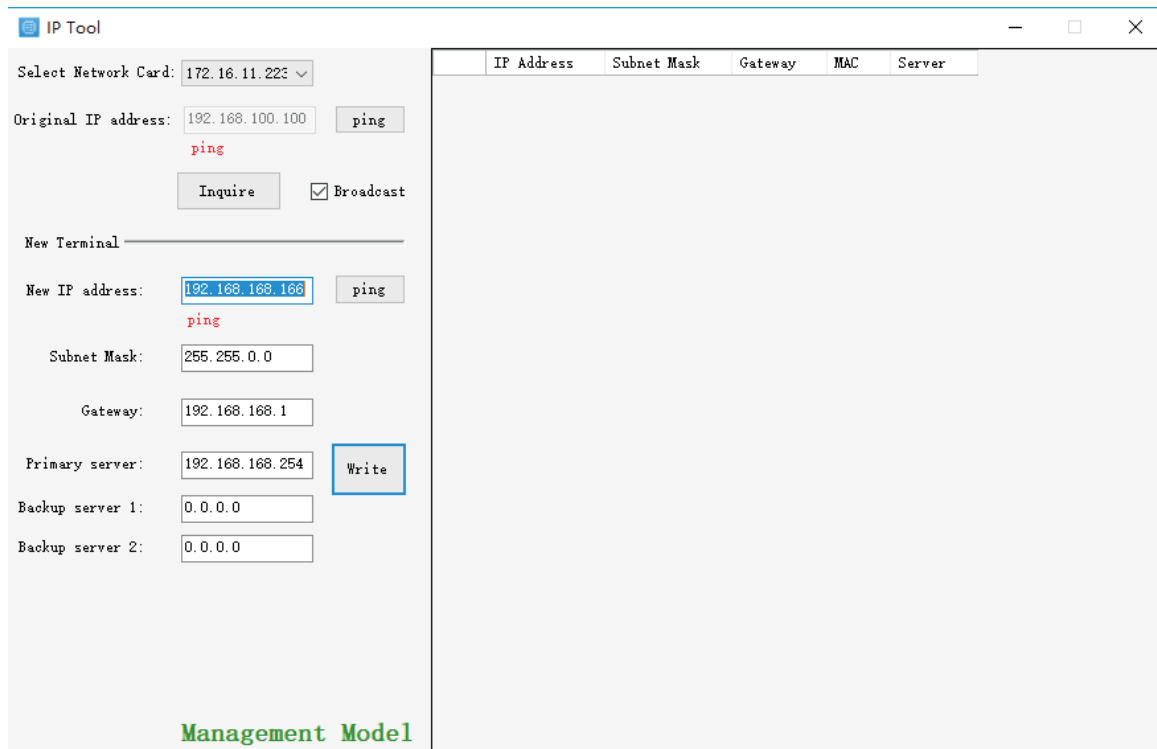

5. TERMINAL CONFIGURATION OPERATING INSTRUCTIONS

The configuration steps:

Step 1: Connect the terminal and the computer installed with the terminal configuration tool program by the network wire, Plug in the power until the terminal power indicator is on.

Step 2: double-click to open the shortcut icon of “ terminal configuration tool”, select the network card first, and left-click the “query” button in the window, to query the terminal’s original IP address. Please pay attention to: local IP address of the computer should be set in the same network segment as the terminal, because the default IP of terminal is : 192.168.168.166, so the computer’s local IP address should also be set to: 192.168.168.X, otherwise it maybe not match the IP terminal address.

Step 3: In the window of “Terminal Configuration Tool” , fill in correct “IP address”, “Subnet mask”, “Gateway IP” and “Server IP”, as below :

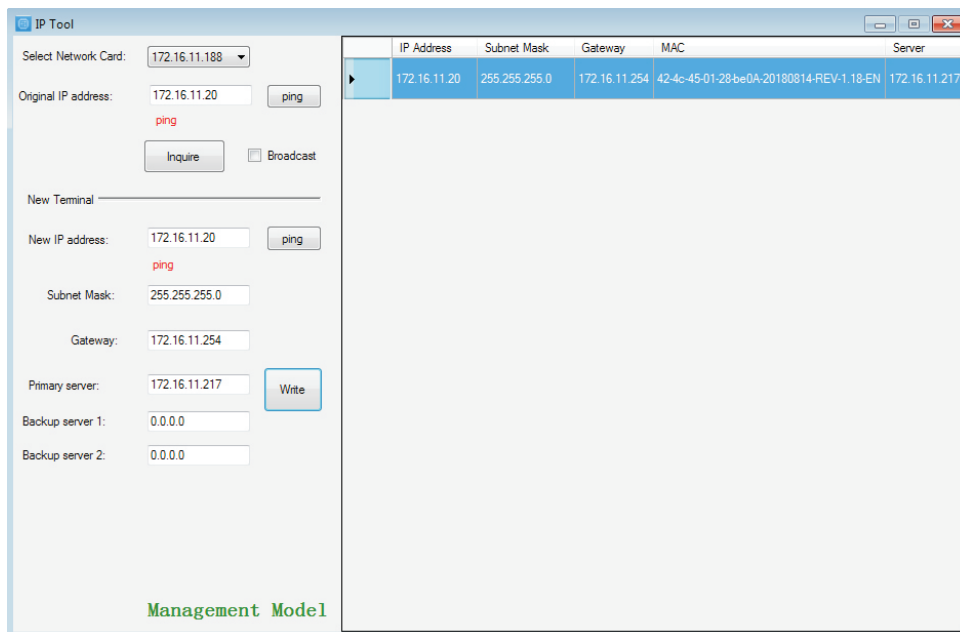

Step 4: left click on the “write” button, there will be a window prompt after the successful configuration; after that, left click on the “query” button, the parameters of the terminal will be re-read by the configuration program, if it display as the same as entered one, means that the configuration was successful.

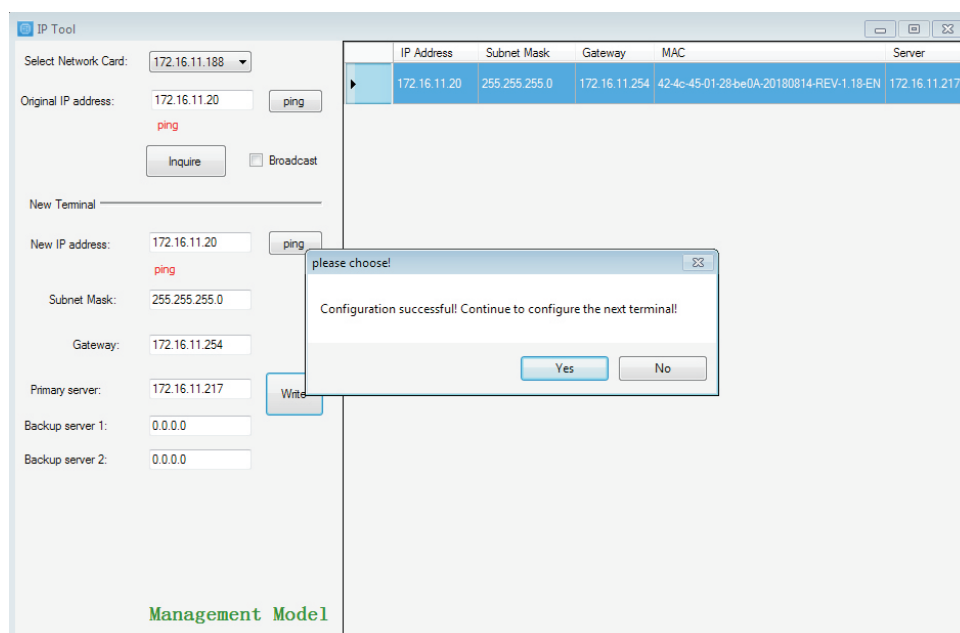

5. TERMINAL CONFIGURATION OPERATING INSTRUCTIONS

Step 5: If multiple terminals are in the same network segment, you only need to modify the IP address of one terminal, it is needed to click on the terminal in the queried terminals list, then cancel the choice of broadcast on the left interface, modify the IP address and click for configuration.

The IP Tool interface consists of a configuration panel on the left and a data table on the right. The configuration panel includes fields for network card selection, original and new IP addresses, subnet mask, gateway, and primary/backup servers. It also has 'ping', 'Inquire', and 'Write' buttons, and a 'Broadcast' checkbox.

Table 1: Terminal Data (Top Screenshot)

IP Address	Subnet Mask	Gateway	MAC	Server
172.16.11.20	255.255.255.0	172.16.11.254	42-4c-45-01-28-be0A-20180814-REV-1.18-EN	172.16.11.217
172.16.11.22	255.255.255.0	172.16.11.254	42-4c-45-00-4E-92F103RCT6-TR-20170225-REV-9.15-CN	172.16.11.228.0.0.0.0.0.0.0
172.16.11.31	255.255.255.0	172.16.11.254	42-4c-45-00-5D-10F103RCT6-TR-20170225-REV-9.15-CN	172.16.11.218.0.0.0.0.0.0.0
172.16.11.34	255.255.255.0	172.16.11.254	42-4c-45-00-51-48F103RCT6-TR-20170225-REV-9.15-CN	172.16.11.218.0.0.0.0.0.0.0
172.16.11.37	255.255.255.0	172.16.11.254	42-4c-45-00-63-F02F103RCT6-20170606-REV-9.17-CN	172.16.11.228.0.0.0.0.0.0.0
172.16.11.38	255.255.255.0	172.16.11.254	42-4c-45-00-FF-002F103RCT6-20170606-REV-9.17-CN	172.16.11.214.0.0.0.0.0.0.0
172.16.11.45	255.255.255.0	172.16.11.254	42-4c-45-00-86-532F103RCT6-20170606-REV-9.17-CN	172.16.11.228.0.0.0.0.0.0.0
172.16.11.63	255.255.255.0	172.16.11.254	42-4c-45-00-17-15	172.16.11.228
172.16.11.66	255.255.255.0	172.16.11.254	42-4c-45-01-9F-902F103RCT6-20170606-REV-9.17-CN	172.16.11.218.0.0.0.0.0.0.0

Table 2: Terminal Data (Bottom Screenshot)

IP Address	Subnet Mask	Gateway	MAC	Server
172.16.11.20	255.255.255.0	172.16.11.254	42-4c-45-01-28-be0A-20180814-REV-1.18-EN	172.16.11.217
172.16.11.22	255.255.255.0	172.16.11.254	42-4c-45-00-4E-92F103RCT6-TR-20170225-REV-9.15-CN	172.16.11.228.0.0.0.0.0.0.0
172.16.11.31	255.255.255.0	172.16.11.254	42-4c-45-00-5D-10F103RCT6-TR-20170225-REV-9.15-CN	172.16.11.218.0.0.0.0.0.0.0
172.16.11.34	255.255.255.0	172.16.11.254	42-4c-45-00-51-48F103RCT6-TR-20170225-REV-9.15-CN	172.16.11.218.0.0.0.0.0.0.0
172.16.11.37	255.255.255.0	172.16.11.254	42-4c-45-00-63-F02F103RCT6-20170606-REV-9.17-CN	172.16.11.228.0.0.0.0.0.0.0
172.16.11.38	255.255.255.0	172.16.11.254	42-4c-45-00-FF-002F103RCT6-20170606-REV-9.17-CN	172.16.11.214.0.0.0.0.0.0.0
172.16.11.45	255.255.255.0	172.16.11.254	42-4c-45-00-86-532F103RCT6-20170606-REV-9.17-CN	172.16.11.228.0.0.0.0.0.0.0
172.16.11.63	255.255.255.0	172.16.11.254	42-4c-45-00-17-15	172.16.11.228
172.16.11.66	255.255.255.0	172.16.11.254	42-4c-45-01-9F-902F103RCT6-20170606-REV-9.17-CN	172.16.11.218.0.0.0.0.0.0.0

Notes: If the terminal data can't be queried or the network is blocked, the pop-up window will say Reconfigure the IP address or IP address writing error. In this case, please reconfigure the network, check the network cable, and turn off the firewall, etc.

6. OPERATION

- 1) When network connection is normal, the panel indicator light is green, press the "CALL" the call button, can call to the CALL center, after the CALL center answering, intercom can be achieved between the two terminals, if unanswered or when more than 120s unanswered, it will prompt each other .
Promised to talk on the phone, the speakers will be each other's voice.
- 2) When CALL center calls to the machine, the speaker will appear a CALL prompt, press the "CALL" the CALL button after the reply, it can be connected both ends of the dialogue, if unanswered or when more than 120s unanswered, it will prompt each other .Promised to talk on the phone, the speakers will be each other's voice.
- 3) When playing the music in the IP network broadcast file, in the speaker and the "LINE OUT", it will have the background music output of the network
- 4) Connected electric door lock, when the door is opening or closing, it will trigger a short circuit signal input to the "SHORT IN" terminal.
- 5) Short circuit output function has two kinds of short circuit output trigger mode is optional:
 - ① When press the "CALL" button on the panel, can CALL the CALL center, it will also trigger the short circuit output function at the same time, it can be used for connecting video or other equipment.
 - ② When playing emergency alarm signal in the IP network broadcasting, in the speaker and the "LINE OUT" there will be a warning signal output, at the same time "SHORT OUT", there will be a short circuit signal output.

7. BLOCK DIAGRAM

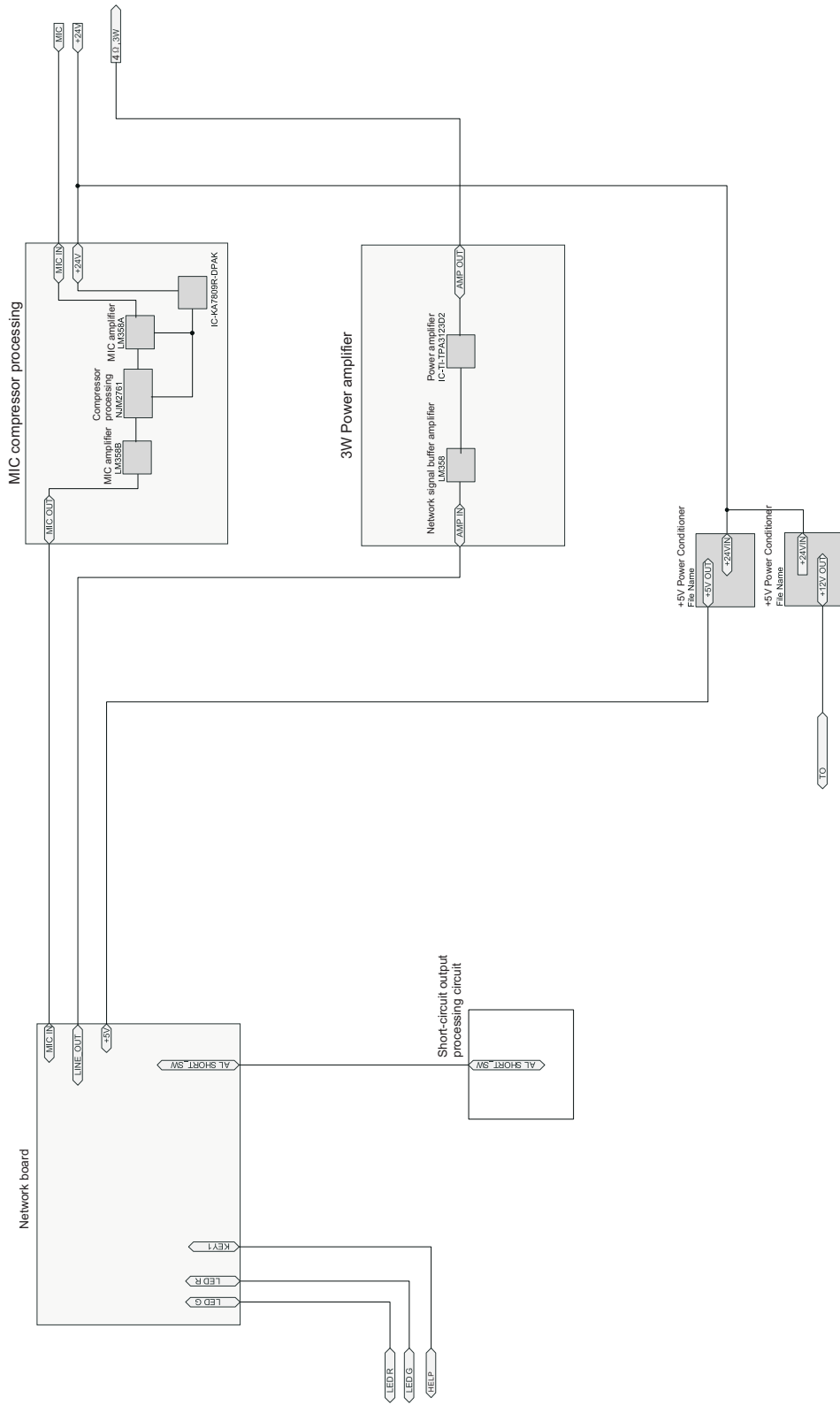

8. SPECIFICATIONS

Model	T-7703E
Network Interface	Standard RJ45 input
Supportive protocol	TCP/IP, UDP, IGMP (Multicast)
Audio Format	MP3/MP2
Sampling Rate	8K~48KHz
Transmission rate	100Mbps
Audio mode	16 bit stereo CD tone quality
THD	≤1%
Frequency Response	80Hz~16KHz +1dB/-3dB
SNR	>70dB
LINE OUT output level	1000mV industrial standard amphenol connector
Operation temperature	5°C~40°C
Operation humidity	20%~80% relative humidity without moisture condensation
Overall power consumption	≤10W
Operating voltage	DC24V
Machine size	132x81x38mm
Net weight	0.9Kg

9. BOTTOM CASE INSTALLATION DIMENSION FIGURE

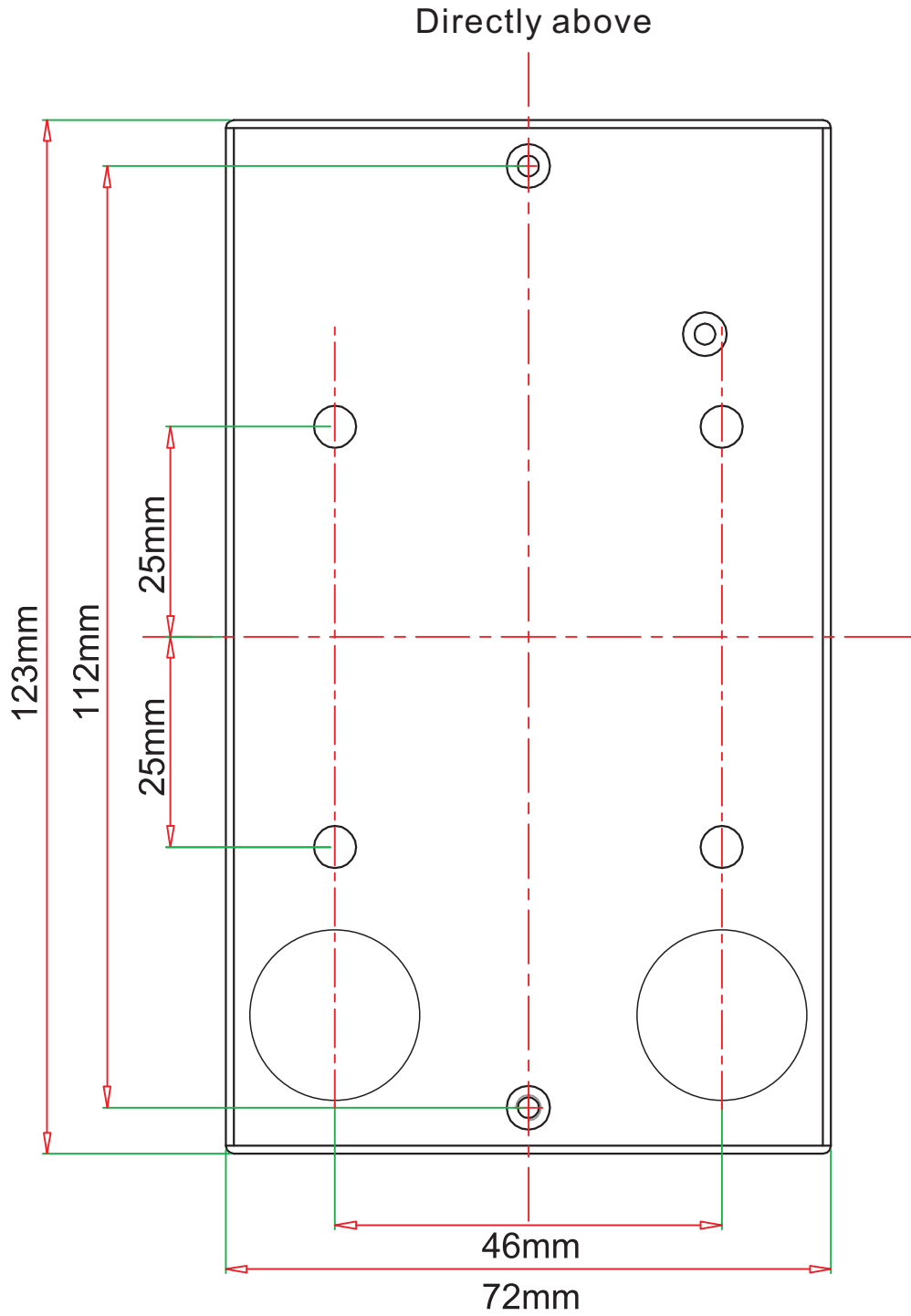

IP NETWORK PA SYSTEM

VersionV0.1

